

# EDIFICIO A

Piano Interrato



1542 mq

Piano Terra



1208 mq

Piano Primo



1258 mq

Piano Secondo

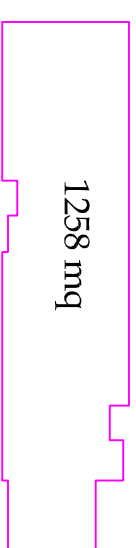

1258 mq

Piano Terzo



1258 mq

Piano Quarto

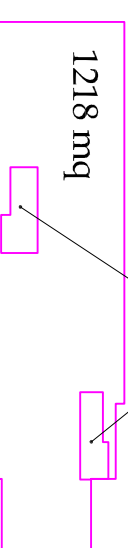

1218 mq

98 mq

# EDIFICIO B1

Piano Interrato

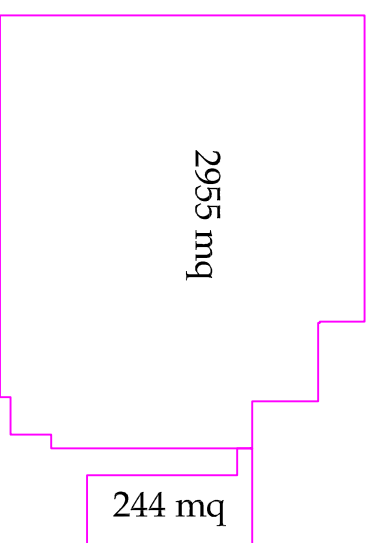

2955 mq

244 mq

Piano Terra

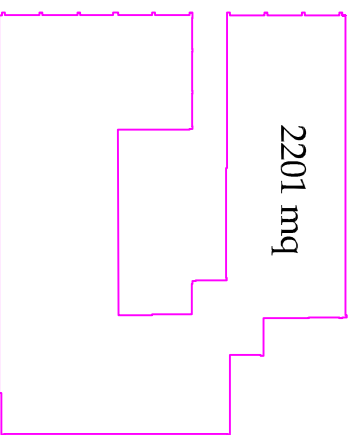

2201 mq

Piano Primo

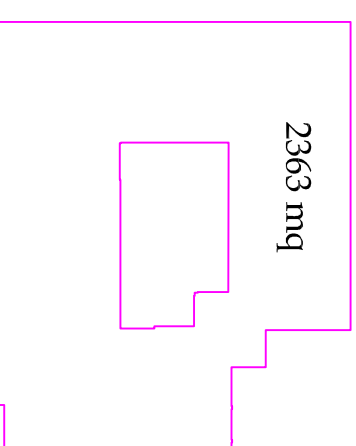

2363 mq

Piano Secondo

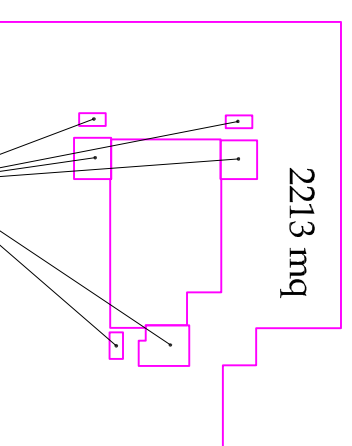

2213 mq

119 mq

# EDIFICIO B2

Piano Interrato

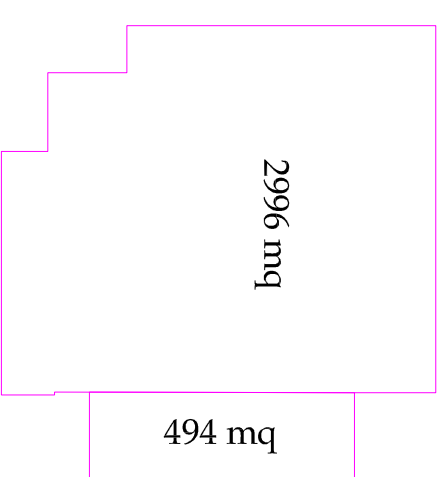

2996 mq

494 mq

Piano Terra

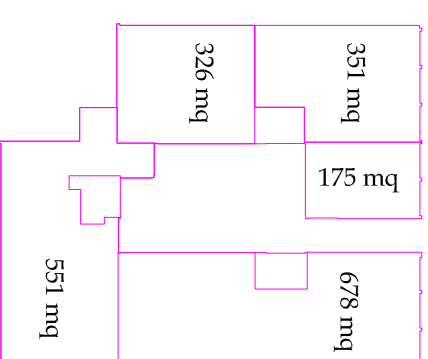

351 mq

326 mq

678 mq

551 mq

175 mq

Piano Primo

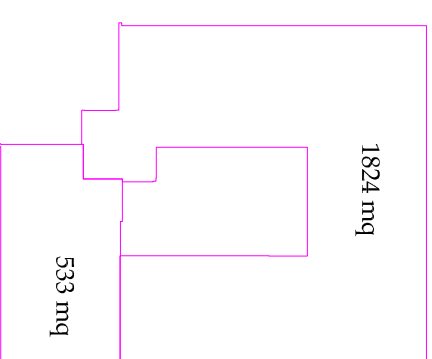

1824 mq

533 mq

Piano Secondo

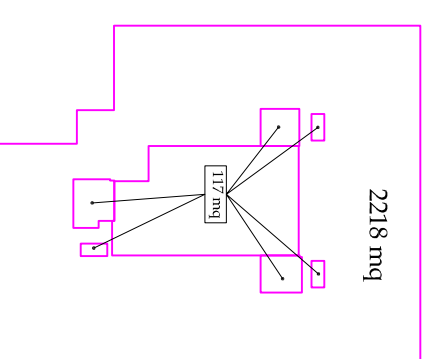

2218 mq

117 mq

# EDIFICIO B3

Piano Interrato

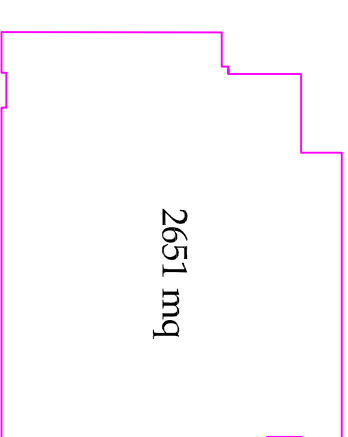

2651 mq

Piano Terra

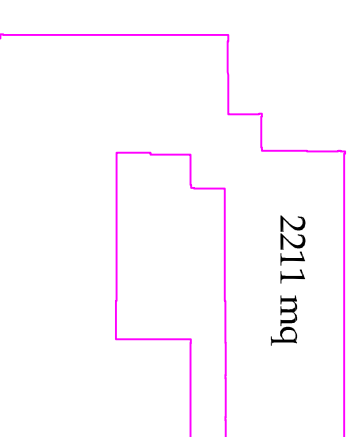

2211 mq

Piano Primo

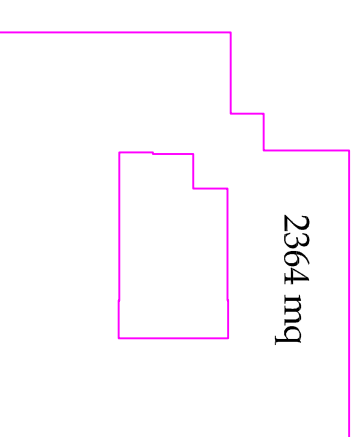

2364 mq

Piano Secondo

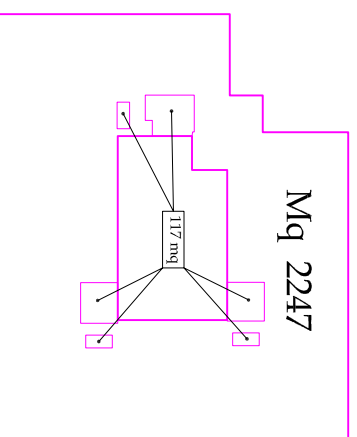

Mq 2247

117 mq